

nomatech

YOUR PACKAGING MACHINES

TOBOGAN 250S

VERTICAL PACKAGING MACHINE

(with multihead weighers and other accessories)

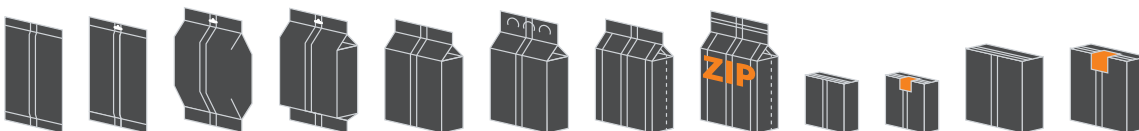
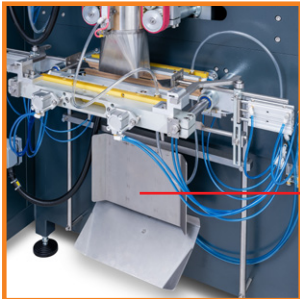
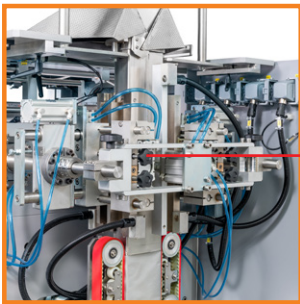

PRODUCTION OF SINGLE BAGS FROM HEAT OR IMPULSE SEALABLE PACKING MATERIAL

Output: up to 100 cycles/min.*

Device dimensions: w 1200 mm | d 1800 mm | h 1600 mm w/o dosing device

Bag dimensions: w 32-250 mm | l 60-350 mm

Packed products: loose (powder, granules) | small, piece | liquids, paste



*depending on packed amount, type of product and size of package

BOX ROBO GROUP ROBOTIC CARTONING DEVICE

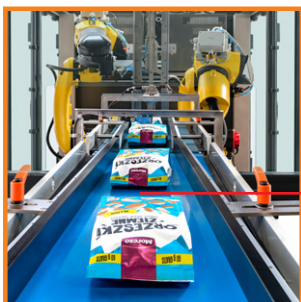

ROBOTIC GROUP PACKING INTO CARTON TRAYS/BOXES

Output: up to 6000 bags/hr.*

Device dimensions: w 1450 mm | d 3935 mm | h 1930 mm

Box dimensions: w 90-180 mm | l 200-400 mm | h 150-200 mm | individual request

Bag dimensions: max. w 150 mm | l 190 mm

Packed products: prepacked bags, boxes



BOX 60V VERTICAL CARTONING DEVICE

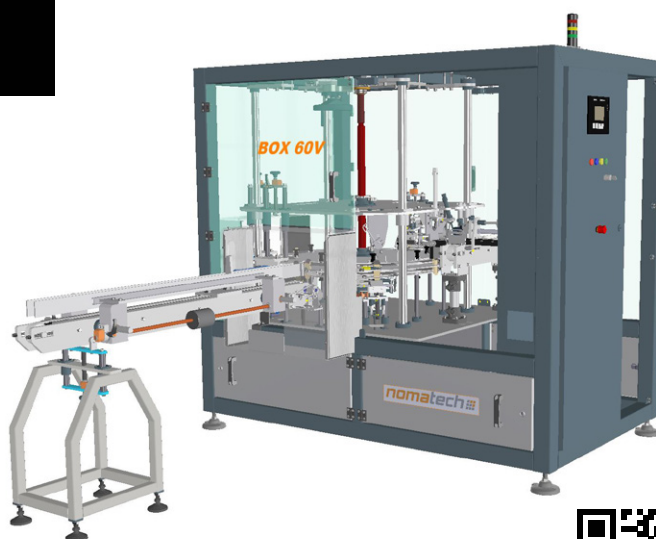
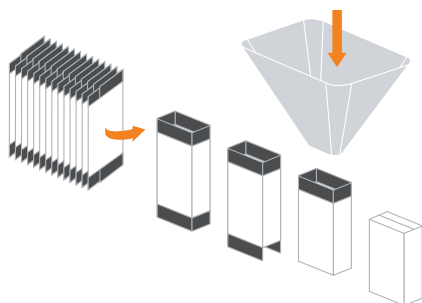

VERTICAL PRODUCT INSERTING INTO CARTON BOXES (TOP LOAD)

Output: up to 3000 packages/hr.*

Device dimensions: w 2350 mm | d 2700 mm incl. feeding conveyor | h 2000 mm

Box dimensions: w 35-180 mm | l 35-180 mm | h 11-80 mm | individual request

Packed products: small, piece | loose | filled bags

Packing options: individual pieces | product groups

Box closing: hot melt | tuck-in system



BOX 60H HORIZONTAL CARTONING DEVICE

(with a horizontal flowpack packaging machine)

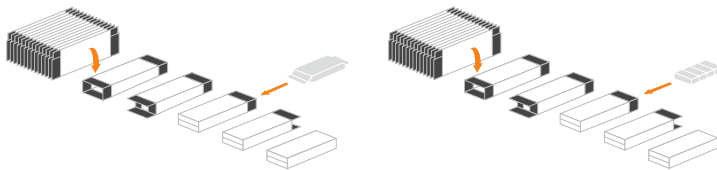
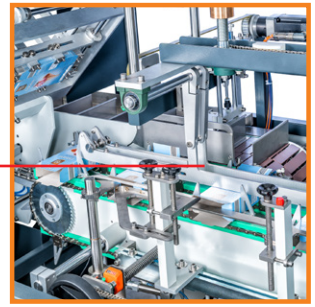
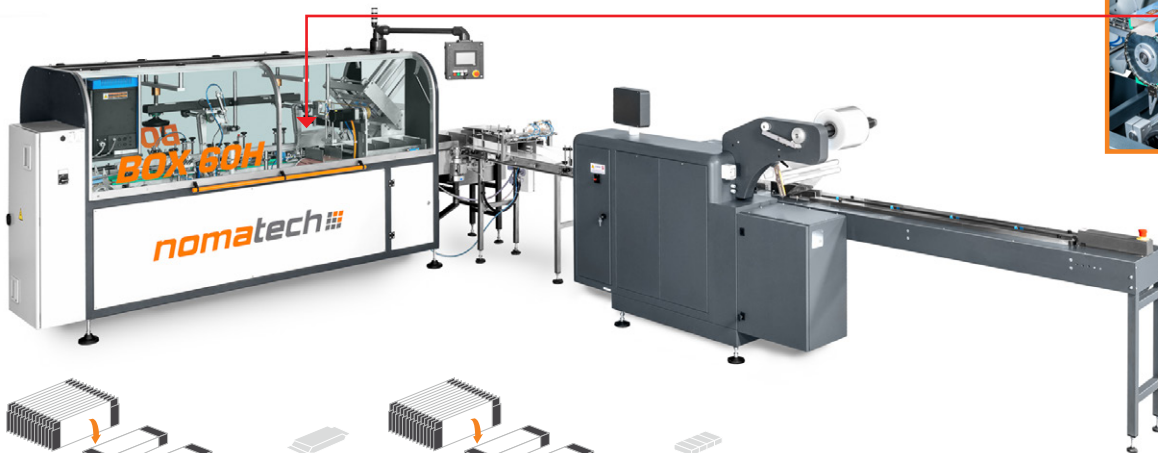

HORIZONTAL PRODUCT INSERTING INTO CARTON BOXES (END LOAD)

Output: up to 3000 packages/hr.*

Device dimensions: w 3980 mm | d 1630 mm incl. feeding conveyor | h 1970 mm

Box dimensions: w 20-250 mm | l 120-300 mm | h 20-100 mm | individual request

Packed products: small, piece | pre-packed

Packing options: individual pieces | product groups

Box closing: hot melt | tuck-in system



BOX 60H mini HORIZONTAL CARTONING DEVICE

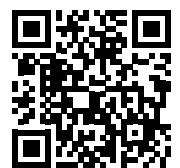
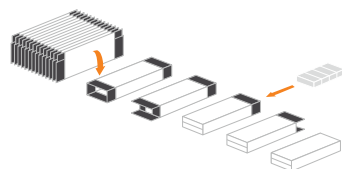
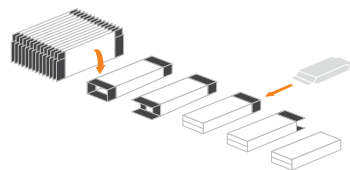
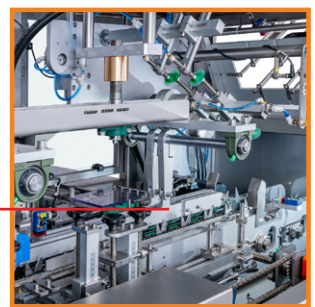
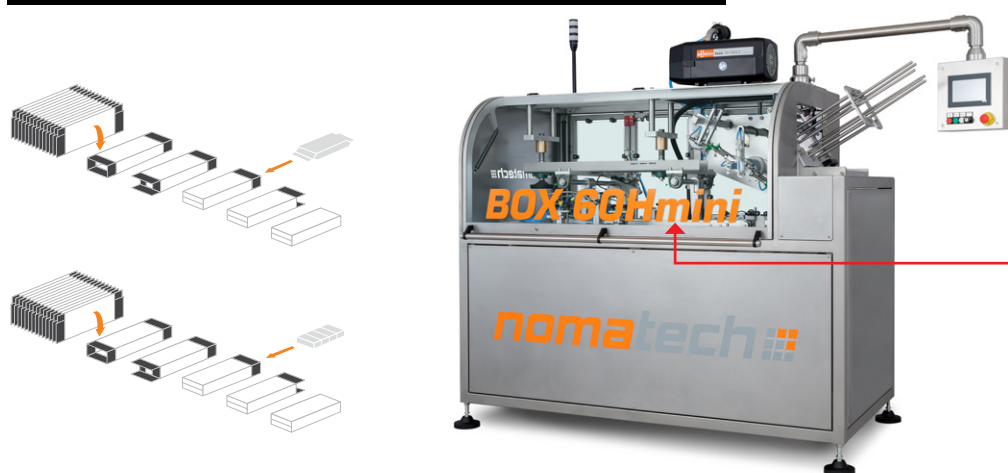

HORIZONTAL PRODUCT INSERTING INTO CARTON BOXES (END LOAD)

Output: up to 3600 packages/hr.*

Device dimensions: w 2270 mm | d 1070 mm | h 2010 mm

Box dimensions: w 20-80 mm | l 70-180 mm | h 13-75 mm | individual request

Packed products: small, piece

Packing options: individual pieces | product groups

Box closing: hot melt | tuck-in system



*depending on packed amount, type of product and size of package

GOLEM 600S BAGGING LINE

(with an auger doser)



FILLING OF PREMADE LARGE VOLUME BAGS

Output: up to 600 bags/hr.*

Device dimensions: w 4970 mm | d 3930 mm | h 2800 mm w/o dosing device

Bag volume: up to 75 l | individual request

Bag closing: sewing | glueing | sealing | stretch band

Packed products: loose (powder, granules) | small, piece



*depending on packed amount, type of product and size of package

OUR MANUFACTURE PROGRAM:

TOBOGAN Vertical packaging machines | **VOLCANO** Multilane stickpack packaging machines
GOLEM Bulk bags packaging machines | **BOX** Cartoning machines | **CUBE** Brickpack packaging lines
CASE Group packaging casepackers | **ROBO** Manipulation lines, palletization
LUNA Filling and mixing lines | Wide range of accessories and more.



NOMATECH s.r.o.
info@nomatech.net | www.nomatech.net | +420 317 843 235
Vlasáková 1635 | 258 01 Vlašim | Czech Republic
Tradition since 1965



Co-funded by
the European Union

nomatech 
YOUR PACKAGING MACHINES